

# POS-SCANNER



TEST AND ADJUSTMENT MANUAL

# DIBAL

Ref: 49-TPOSE-PSC-EN02

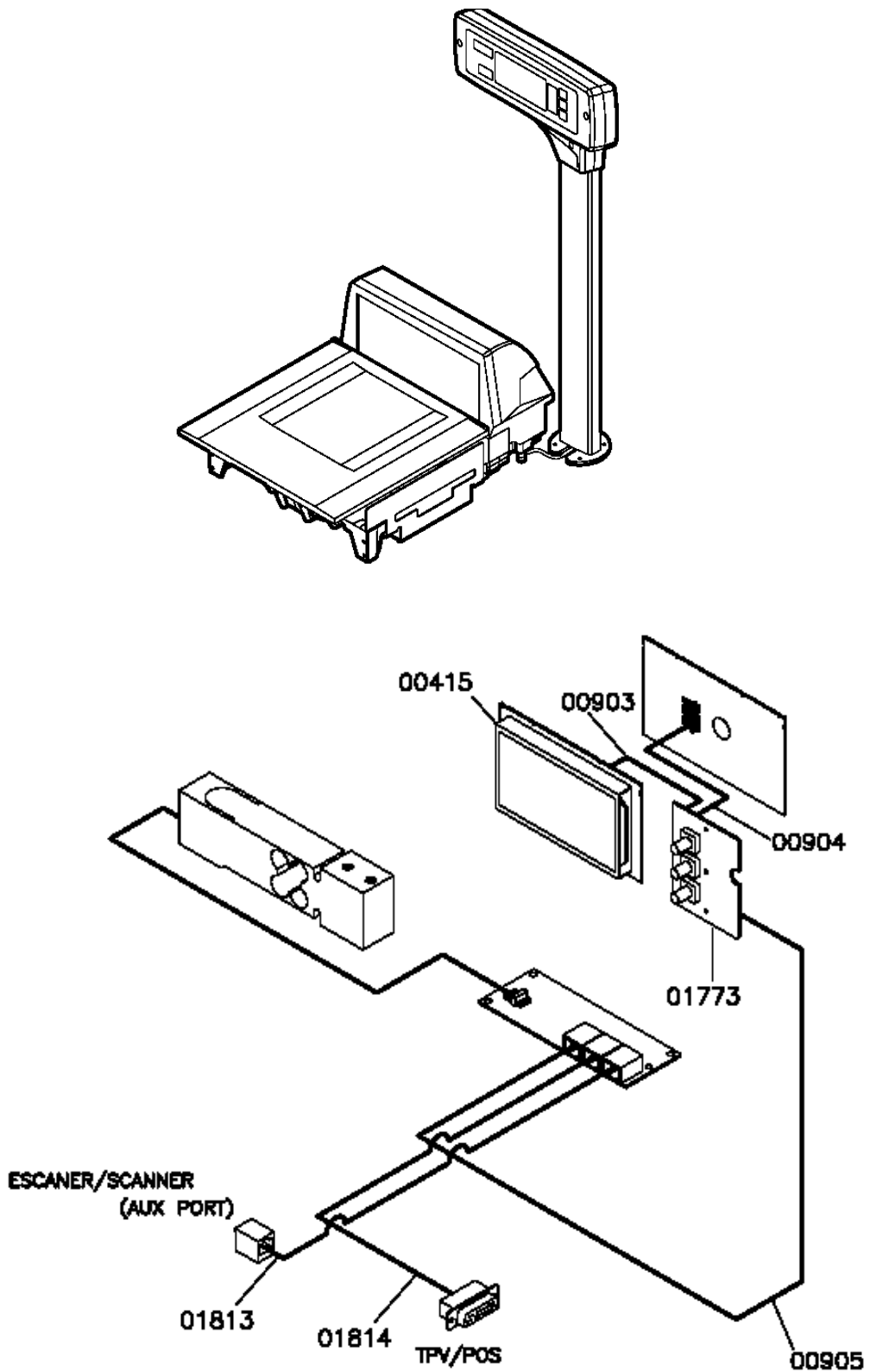

**TABLE OF CONTENTS**

<b>1. ASSEMBLY .....</b>	<b>1</b>
1.1. ASSEMBLY ELEMENTS .....	2
1.2. ASSEMBLY PROCEDURE .....	2
1.2.1. <i>Assembly of the Weighing kit in the scanner chassis.</i> .....	2
1.2.2. <i>Leveling.</i> .....	4
1.3. PLATE MOUNTING .....	5
<b>2. CONNECTIONS.....</b>	<b>6</b>
2.1. CONNECTION SCALE-SCANNER.....	6
2.2. CONNECTION SCALE-DISPLAY .....	7
2.3. MAINS SUPPLY CONNECTION.....	7
<b>3. TEST.....</b>	<b>8</b>
3.1. ENTERING TEST MODE. ....	8
3.2. DISPLAY TEST.....	8
3.3. KEYBOARD TEST.....	8
<b>4. ADJUSTMENT.....</b>	<b>9</b>
4.1. COUNTRY PROGRAMMING. ....	9
4.2. OIML PROGRAMMING. ....	9
4.3. CAPACITY PROGRAMMING.....	9
4.4. ADJUSTMENT.....	10
4.5. LATITUDE ADJUSTMENT. ....	10
4.6. ALTITUDE ADJUSTMENT. ....	10
4.7. ZERO WEIGHT ADJUSTMENT. ....	10
4.8. WEIGHT ADJUSTMENT. ....	11
<b>5. TELECHARGE.....</b>	<b>12</b>
5.1. DESCRIPTION OF TELECHARGE CABLE BB-5918.....	12
5.2. CONNECTION FOR TELECHARGE.....	12
5.3. COMMUNICATIONS.....	13
5.4. PROGRAMMING OF COMMUNICATIONS.....	14
5.4.1. <i>Communication characteristics</i> .....	14
5.5. COMMUNICATION PROTOCOLS .....	14
5.5.1. <i>Selection of Protocol.</i> .....	14
5.5.2. <i>Characteristics of the protocols</i> .....	7
5.5.3. <i>Operation</i> .....	7
5.6. INFORMATION IN THE DISPLAY.....	7
5.7. PROTOCOLS TYPE .....	8
5.7.1. <i>Anker Cash Register Protocol</i> .....	8
5.7.2. <i>Tpv Casio Ce Protocol</i> .....	8
5.7.3. <i>Riva / Uniwell Cash Register Protocol</i> .....	9
5.7.4. <i>Tisa Cash Register Protocol</i> .....	9
5.7.5. <i>Ean Cash Register Protocol To Pc Icl</i> .....	9
5.7.6. <i>Sanyo Cash Register Protocol</i> .....	10
5.7.7. <i>Apollo/Samsung Poland / Posnet Poland Cash Register Protocol</i> .....	10
5.7.8. <i>Delta Cash Register Protocol</i> .....	10
5.7.9. <i>Alfa Cash Register Protocol</i> .....	11
4.3.10. <i>Samsung-Spain Cash Register Protocol</i> .....	11
4.3.11. <i>Samsung Portugal Cash Register Protocol</i> .....	11
4.3.12. <i>Uniprox / Bmc Ps 2000 Cash Register Protocol</i> .....	11
4.3.13. <i>Uniprox With Checksum Cash Register Protocol</i> .....	12
4.3.14. <i>Sharp Up-700 Cash Register Protocol</i> .....	12
4.3.15. <i>Kabel Cash Register Protocol</i> .....	13
4.3.16. <i>Nci Cash Register Protocol</i> .....	13



**1. ASSEMBLY**



# POS-SCANNER

---

## 1.1. ASSEMBLY ELEMENTS

- 1.- Weighing kit ( including CPU, loadcell and plate holder). This kit is already assembled.
- 2.- Column with two displays ( vendor and buyer) including the connection cable between scale and display.
- 3.- Connection cable scale-scanner (Ref: BB-5897).
- 4.- Screws (4 allen type n° 4 screws).
- 5.- Communications cable wit PC or TPV (Ref. BB-5896)

## 1.2. ASSEMBLY PROCEDURE

### 1.2.1. *Assembly of the Weighing kit in the scanner chassis.*

Place the weighing kit in front of the scanner chassis.

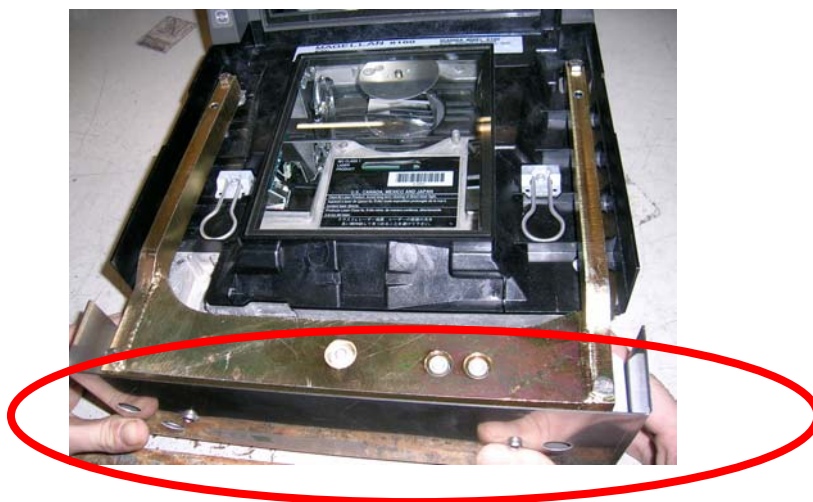

# TEST AND AJUSTMENT MANUAL



Once the kit is placed in the right position, it must be screwed by means of the 4 allen screws.

## 1.2.2. Leveling

Once the kit has been screwed, the scale must be leveled by means of the vial placed in the front of the scale. To modify the leveling, the legs of the scale must be turned.

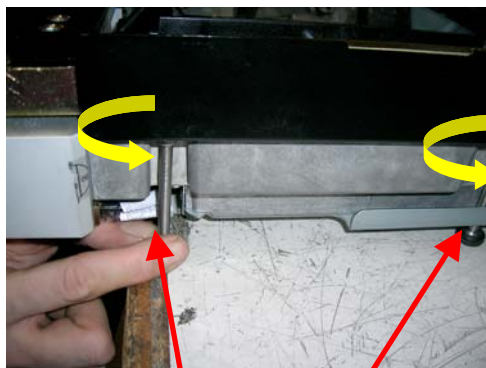
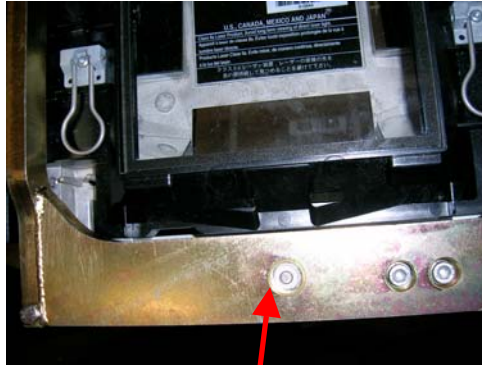

Turn the legs for levelling



## 1.3. PLATE MOUNTING

Place the plate on the plate holder and verify the right leveling of the plate by means of an external level. To fix the levelling of the plate, use the plate leveling screws.

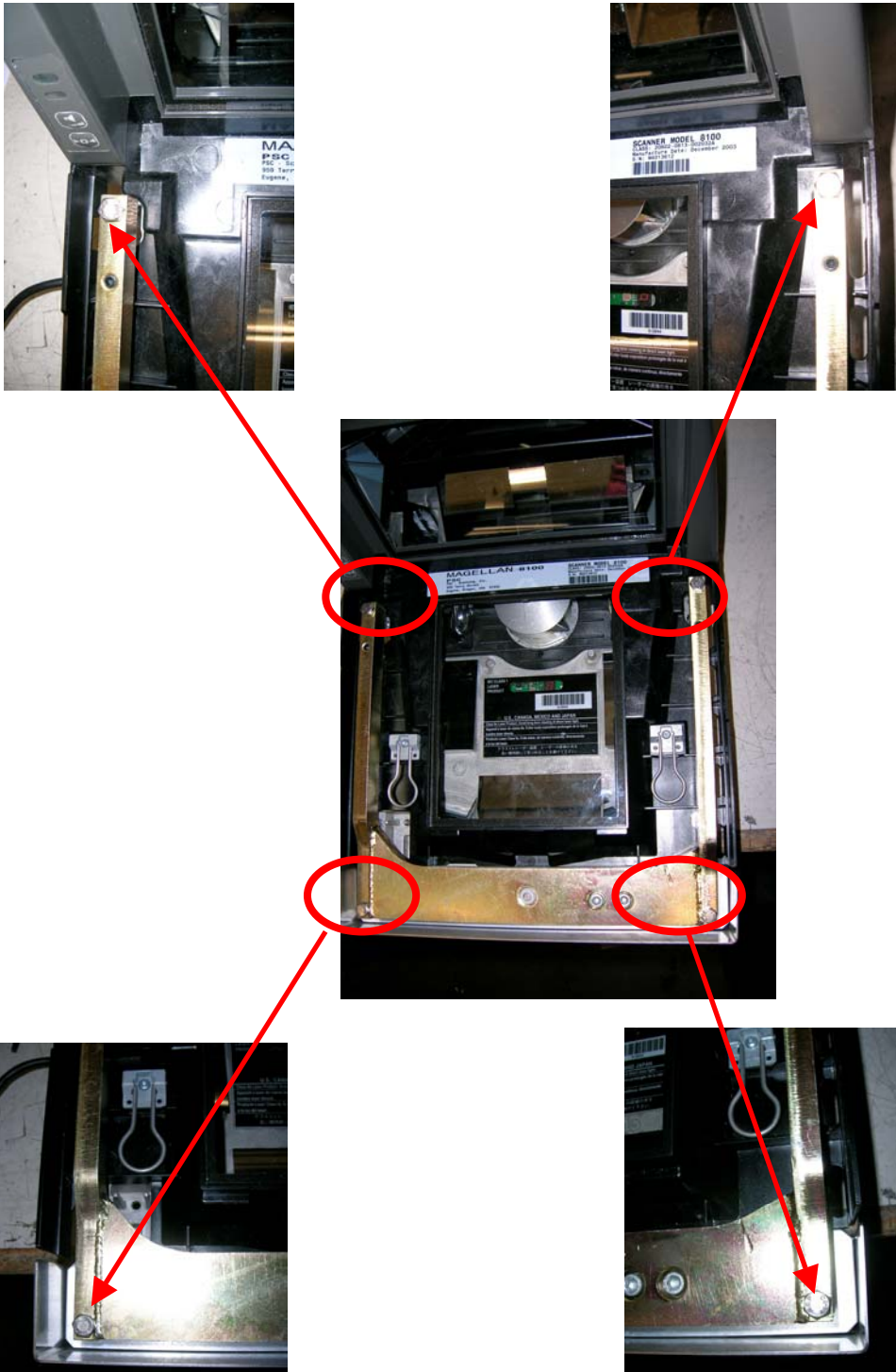

Once the plate is leveled, the position of the screws must be fixed by means of an adhesive type LOCTITE 242 or similar.

The scanner scale is now completely assembled.

# POS-SCANNER

## 2. CONNECTIONS

### 2.1. CONNECTION SCALE-SCANNER

The reference of the connection cable Scale-Scanner is BB-5897.

This cable must be plugged in one side in the connector marked as SCALE SCANNER of the scale and in the other side in the connector marked as AUX PORT of the scanner.

**IMPORTANT:** *This cable is polarised, so, there is an identification mark placed on the cable, the side where the identification mark is placed must be plugged to the scale connector.*

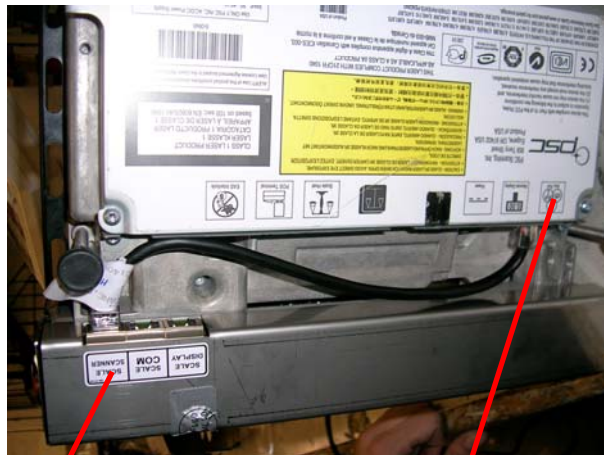

**TO SCALE**

**TO SCANNER**

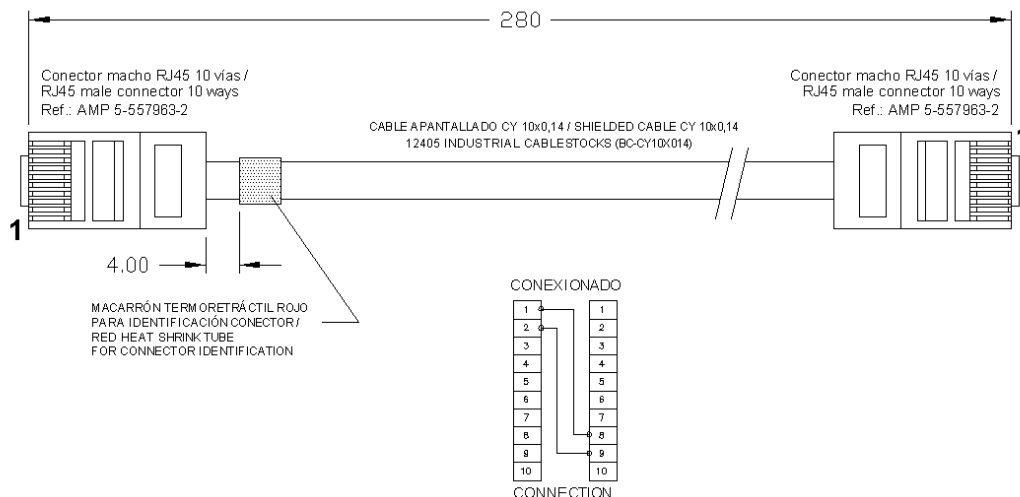

## 2.2. CONNECTION SCALE-DISPLAY

The connection cable display-scale is supplied mounted and plugged in the displays, the other side must be plugged in the connector marked as SCALE DISPLAY of the scale.



## 2.3. MAINS SUPPLY CONNECTION



The connection of the scanner to the mains supply must be done by means of the connector and the supply cable of the scanner.



## 3. TEST

The test functions permit the user to check all of the important elements of the scale in order to assure that they function correctly; or in the case of a malfunction, find the faulty element quickly. The scale must be turned off to leave test mode.

### 3.1. ENTERING TEST MODE.

When the scale is turned on, a segment test is run showing a count down from 9 to 0. **To enter test mode**, press:  and  simultaneously before 0 is reached. Backlighting is on while the equipment is in mode test.

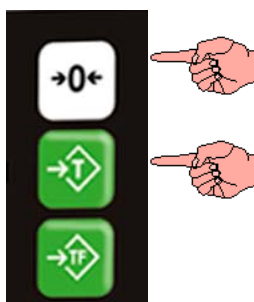

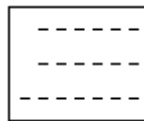
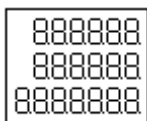

The scale will show hyphens in all the display's digits, followed by the following information.

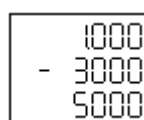
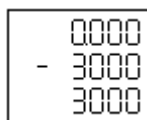

1. The weight value in grams is shown in the weight display.
2. The zero weight value in internal divisions is shown in the price per kilogram display. This value is accompanied by a hyphen, which is in the center segment if the value is in the limits set when the scale was adjusted, or in the upper or lower segments if the value is greater or lesser than the limits respectively.
3. The weight value in internal divisions is shown in the amount display.



### 3.2. DISPLAY TEST.

This is for checking that there are no visualisation problems. In test mode, press  and then keep  pressed to view all segments, until  is released.

Press  to exit.

### 3.3. KEYBOARD TEST.



This is for checking that all the keys are working.

During countdown, press each key. The countdown should pause every time a key is pressed, which will indicate that the pressed key has been received.

## 4. ADJUSTMENT

These functions allow the user to program, adjust and calibrate the scale. **IMPORTANT NOTE:** this should only be done by authorized personnel.

The scale must be turned on for at least two hours before being adjusted. It must also be perfectly level and the temperature and humidity must be stable. The user must have a calibrated weight relative to the scale capacity.

Switch on the scales and enter test and adjustment mode. To do this, during countdown from 9 to 0, press  and  at the same time. The scales will go into test mode. Then press the adjustment key situated on top of the CPU. This key can be pressed by removing a security-covered screw and inserting a pointed object in the hole.

The following may be programmed:

### 4.1. COUNTRY PROGRAMMING.

This parameter is only used for consultation. Change of country must be remote loaded in the scale.

Press  to go to the next parameter.

### 4.2. OIML PROGRAMMING.

This allows the user to set a series of parameters as recommended by the OIML. To do so, program a 1 as the default value. This will also appear each time the country programmed is changed.

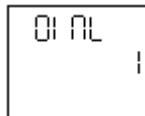

Press  to go to the next parameter.

### 4.3. CAPACITY PROGRAMMING.

This allows the scale capacity to be selected according to the following table.



The following is the capacity table.

Code	Maximum Capacity
1	6 kg
2	15 kg
3	30kg
16	6/15kg MR
17	15/30 kg MR

Press  to reduce the value and  to increase it.

Press  to go to the next parameter.

## 4.4. ADJUSTMENT.

This allows an adjustment to be done. The default value of 0 will always be shown. Change this to a value of 1 and press the '\*' key. **Do not enter this option if you are not qualified or if you do not have the calibrated weights.**





Press  to go to the next parameter.

## 4.5. LATITUDE ADJUSTMENT.

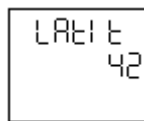
This allows the adjustment to be modified according to the latitude at which the scale is to operate without carrying out a complete adjustment with calibrated weights. Program a value between 0 and 90.



Press  to modify the value of the flashing digit.

Press  to select the other digit.

Press  to go to the next parameter.

## 4.6. ALTITUDE ADJUSTMENT.

This allows the adjustment to be modified according to the altitude at which the scale is to operate without carrying out a complete adjustment with calibrated weights. Program a value between 0 and 9999 corresponding to meters above sea level.





Press  to modify the value of the flashing digit.

Press  to select the other digit.

Press  to go to the next parameter.

## 4.7. ZERO WEIGHT ADJUSTMENT.

This will carry out a non-reversible calibration process with the scale. To do this adjustment, the user must have the corresponding calibrated weights according to the maximum scale capacity. To leave adjustments without doing this adjustment, press the  key. If the adjustment is to be done, remove all of the weight from the plate and press the  key to begin the zero weight adjustment. During the adjustment process, the display will show hyphens. This process lasts various seconds.

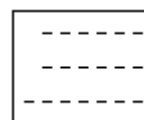
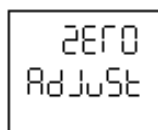

## 4.8. WEIGHT ADJUSTMENT.

Once the zero weight adjustment is made, the display will show a default weight, relative to the scale capacity, to be used in the weight adjustment. This adjustment weight may be modified by using the keyboard. Place a calibrated weight matching exactly the weight shown in the display on the weighing platform and wait a few seconds for the weight to stabilize. Press the  key to begin the weight adjustment. The display will show lines of hyphens while the adjustment is being done. This process will last for a few seconds.





WEIGHT  
ADJUST  
10000



-----  
-----  
-----

Once the adjustment process has been completed correctly, the scale will return to test ready automatically. If an error occurs during the adjustment, press the  key to return to test ready and retry the adjustment process.

Press  to modify the value of the flashing digit.

Press  to select the other digit.

Press  to go to the next parameter.

## 5. TELECHARGE

The reference of the Telecharge cable is BB-5918.

### 5.1. DESCRIPTION OF TELECHARGE CABLE BB-5918

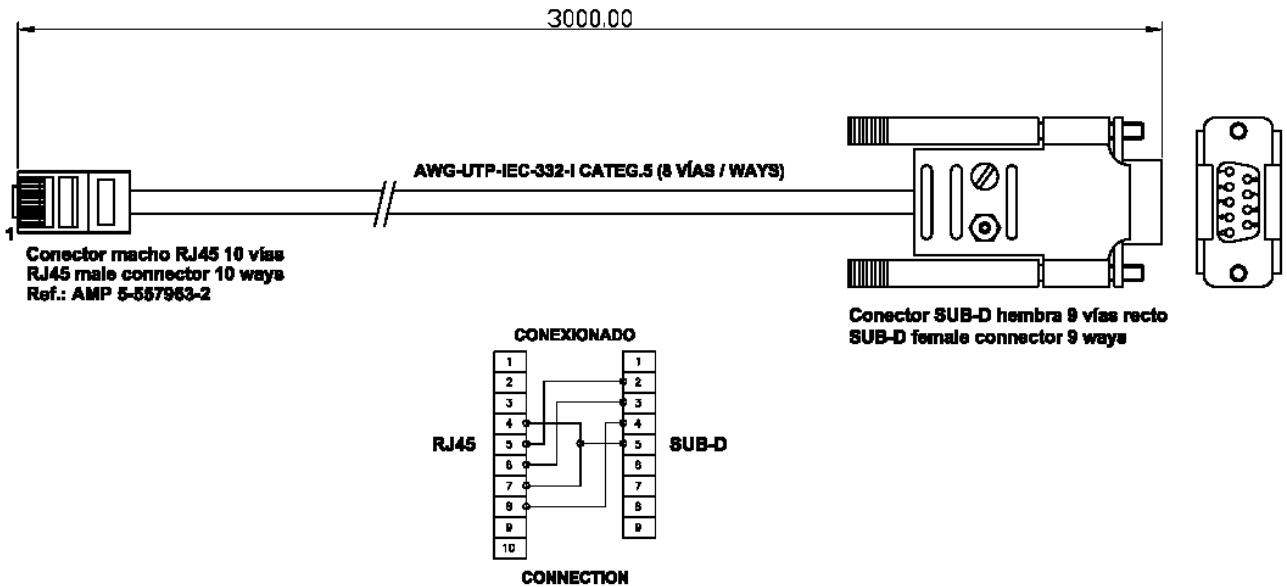

### 5.2. CONNECTION FOR TELECHARGE

The Telecharge cable Ref: BB-5918 must be connected to the Telecharge connector of the CPU.

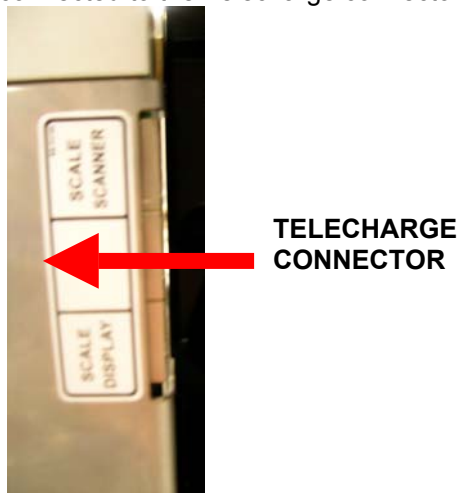



## 5.3. COMMUNICATIONS

The cable to connect the scale to PC or POS has the reference BB-5896 and it must be plugged in the connector marked as SCALE COM of the scale.

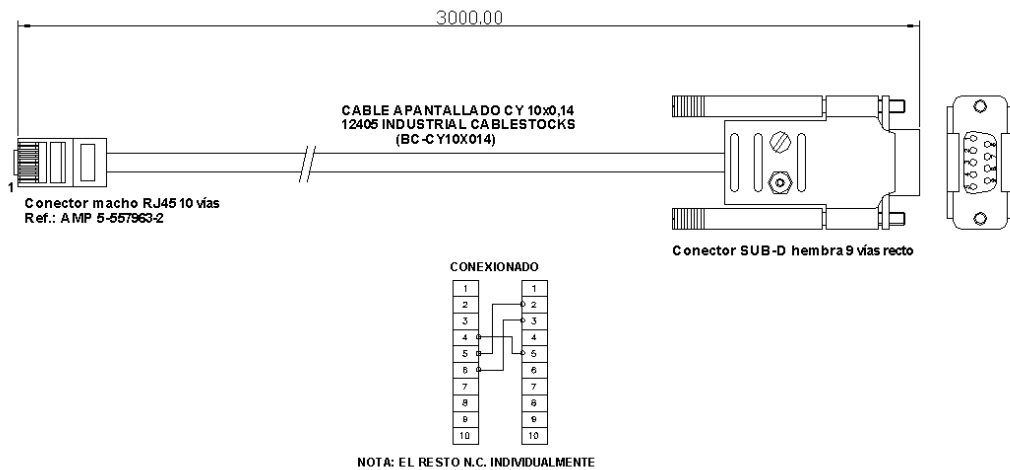

**ⓘ Never use a communications cable different to the one shown above.**

## 5.4. PROGRAMMING OF COMMUNICATIONS.

### 5.4.1. Communication characteristics

For programming of communications, the process is as follows:

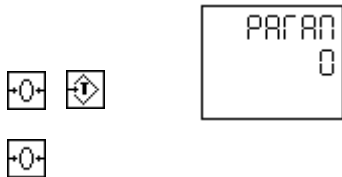

1. Enter test mode by simultaneously pressing and while the scales are effecting the countdown after switching on.
2. Press .
3. Select the type of communication in accordance with the table below:

Type	Bauds	Data Bits	Stop Bits	Parity
0	9600	8	1	No
1	9600	8	1	Even
2	9600	8	1	Odd
3	9600	8	2	No
4	9600	7	1	Even
5	9600	7	1	Odd
6	9600	7	2	Even
7	9600	7	2	Odd
8	19200	8	1	No
9	19200	8	1	Even
10	19200	8	1	Odd
11	19200	8	2	No
12	19200	7	1	Even
13	19200	7	1	Odd
14	19200	7	2	Even
15	19200	7	2	Odd
16	4800	8	1	No
17	4800	8	1	Even
18	4800	8	1	Odd
19	4800	8	2	No

Type	Bauds	Data Bits	Stop Bits	Parity
20	4800	7	1	Even
21	4800	7	1	Odd
22	4800	7	2	Even
23	4800	7	2	Odd
24	2400	8	1	No
25	2400	8	1	Even
26	2400	8	1	Odd
27	2400	8	2	No
28	2400	7	1	Even
29	2400	7	1	Odd
30	2400	7	2	Even
31	2400	7	2	Odd
32	1200	8	1	No
33	1200	8	1	Even
34	1200	8	1	Odd
35	1200	8	2	No
36	1200	7	1	Even
37	1200	7	1	Odd
38	1200	7	2	Even
39	1200	7	2	Odd

Press to reduce the value and to increase the value

Having selected the type of communication, press to save it and then select the protocol.

## 5.5. COMMUNICATION PROTOCOLS

### 5.5.1. Selection of Protocol

This selects the type of communications protocol. The protocol should be saved in the scales' flash memory. If this is not the case, it should be saved using the protocol loading programme from the PC.

Enter the protocol number and press

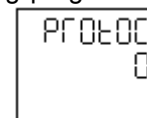

Implemented protocols are as follows:

- |                     |                             |
|---------------------|-----------------------------|
| 0. NO PROTOCOL      | 8. DELTA                    |
| 1. ANKER            | 9. ALFA                     |
| 2. CASIO CE at 9600 | 10. SAMSUNG ESPAÑA          |
| 2. CASIO CE at 2400 | 11. SAMSUNG PORTUGAL        |
| 3. RIVA             | 12. UNIPROX                 |
| 3. UNIWELL          | 12. BMC PS 2000             |
| 4. TISA             | 13. UNIPROX (with checksum) |
| 5. EAN at PC ICL    | 14. SHARP UP 700            |
| 6. SANYO            | 15. KABEL                   |
| 7. SAMSUNG POLONIA  | 16. NCI                     |
| 7. POSNET POLONIA   |                             |

## 5.5.2. Characteristics of the protocols



Protocol	Type	Protocol	Type
1-ANKER	0	8-DELTA	1
2-CASIO CE at 9600	4	9-ALFA	1
2-CASIO CE at 2400	24	10-SAMSUNG ESPAÑA	0
3-RIVA	2	11-SAMSUNG PORTUGAL	4
3-UNIWELL	28	12-UNIPROX	0
4-TISA	0	12-BMC PS2000	4
5-EAN at PC ICL	1	13-UNIPROX (with checksum)	0
6-SANYO	5	14-SHARP UP700	29
7-APOLLO/SAMSUNG POLONIA	0	15-KABEL	0
7-POSTNET POLONIA	0	16-NCI	-

## 5.5.3. Operation

Having configured the type of device with which communication is to be established, simply effect the desired operation from the corresponding PC, and the scales will automatically send the weight message.

① Except for protocols 9 in which communication commences by pressing .

## 5.6. INFORMATION IN THE DISPLAY

Switch on the scales and enter test and adjustment mode. To do this, during countdown from 9 to 0, press  and  at the same time. The scales will go into test mode. Push the .key. In the display we will see this:

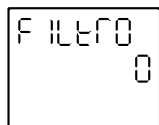

Change the value with the key .

0 = Only Weight.

1 = Eeight, Price and amount

Push  for value. Switch off the scale..

## 5.7. PROTOCOLS TYPE

### 5.7.1. Anker Cash Register Protocol

#### Protocol

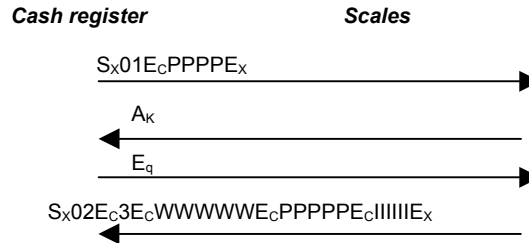

Where.

**S<sub>x</sub>**: 0x02h      **A<sub>K</sub>**: 0x06h  
**01**: 0x30 y 0x31h  
**E<sub>c</sub>**: 0x1Bh      **E<sub>x</sub>**: 0x03h  
**WWWWW**: 5 digits for the WEIGHT.  
**PPPPP**: 5 digits for the PRICE.  
**IIIII**: 6 digits for the SUM

### 5.7.2. Tpv Casio Ce Protocol

#### Protocol

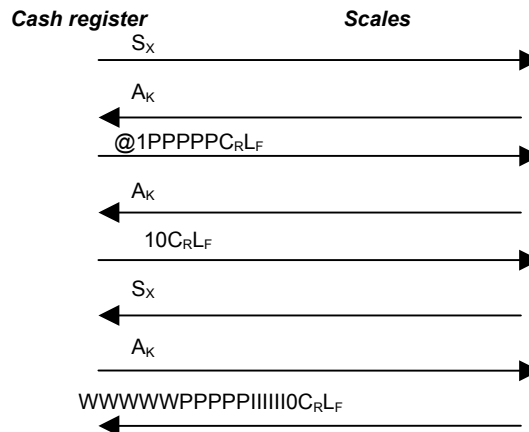

Where:

**S<sub>x</sub>**: 0x02h      **A<sub>K</sub>**: 0x06h  
**@1**: 0x40h y 0x31h      **10**: 0x31h y 0x30h  
**C<sub>R</sub>**: 0x0Dh      **L<sub>F</sub>**: 0x0Ah  
**WWWWW**: 5 digits for WHEIGT.  
**PPPPP**: 5 digits for PRICE  
**IIIII**: 6 digits for SUM

## 5.7.3. Riva / Uniwell Cash Register Protocol

### Protocol

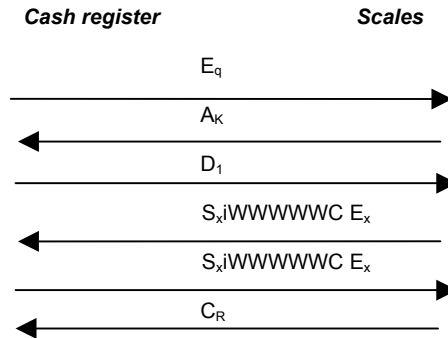

Where:

<b>E<sub>q</sub>:</b> 0x05h	<b>A<sub>K</sub>:</b> 0x06h
<b>D<sub>1</sub>:</b> 0x11h	<b>S<sub>x</sub>:</b> 0x02h
<b>i:</b> 0x69h	
<b>WWWWW:</b> 5 digits for WEIGHT	
<b>C:</b> Checksum, logical sum (XOR) starting from i.	
<b>E<sub>x</sub>:</b> 0x03h	<b>C<sub>R</sub>:</b> 0x0Dh

## 5.7.4. Tisa Cash Register Protocol

### Protocol



Where:

<b>98:</b> 0x38h y 0x39h	
<b>PPPPP:</b> 5 digits for the price.	
<b>C:</b> Checksum, logical sum (XOR) of all previous characters.	
<b>C<sub>R</sub>:</b> 0x0Dh	<b>L<sub>F</sub>:</b> 0x0Ah
<b>99:</b> 0x39h y 0x39h	
<b>S:</b> Weight status.	
S: 0x30h Correct.	
S: 0x31h Error.	
<b>WWWWW:</b> 5 digits for WEIGHT.	
<b>E:</b> Sum status.	
E: 0x30h Correct.	
E: 0x31h Error.	
<b>IIIII:</b> 6 digits for SUM	

## 5.7.5. Ean Cash Register Protocol To Pc Icl

### Protocol

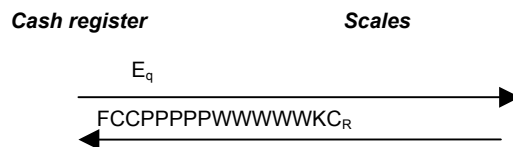

Where:

<b>E<sub>q</sub>:</b> 0x05h	
<b>F:</b> 0x40h	
<b>CC:</b> 0x35h y 0x35h Configurable barcode heading.	
<b>PPPPP:</b> 5 digits for PRICE.	
<b>WWWWW:</b> 5 digits for WEIGHT.	
<b>K:</b> Checksum, logical sum (XOR) of all previous characters.	
<b>C<sub>R</sub>:</b> 0x0Dh	

## 5.7.6. Sanyo Cash Register Protocol

### Protocol

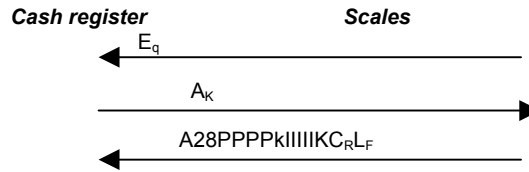

#### Where:

<b>E<sub>q</sub>:</b>	0x05h	<b>A<sub>k</sub>:</b>	0x06h
<b>A :</b>	0x41h	<b>2 :</b>	0x32h
<b>8 :</b>	0x38h		
<b>PPPP:</b>	4 digits for the PRICE		
<b>k:</b>	Partial checksum of the first 7 characters sent		
<b>IIII :</b>	5 digits for the SUM		
<b>K:</b>	Total checksum of the 13 characters sent.		
<b>C<sub>R</sub>:</b>	0x0Dh	<b>L<sub>F</sub>:</b>	0x0Ah

## 5.7.7. Apollo/Samsung Poland / Posnet Poland Cash Register Protocol

### Protocol

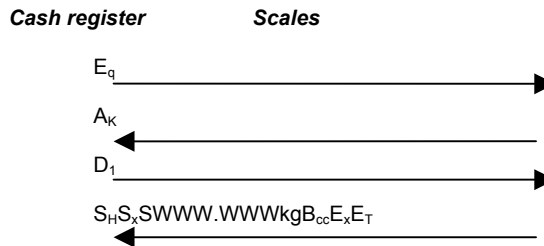

#### Where:

<b>E<sub>q</sub>:</b>	0x05h	<b>A<sub>k</sub>:</b>	0x06h
<b>D<sub>1</sub>:</b>	0x11h		
<b>S<sub>H</sub>:</b>	0x01h	<b>S<sub>x</sub>:</b>	0x02h
<b>S:</b>	Weight status.		
	S: 0x30h Correct.		
	S: 0x31h Error.		
<b>WWWWW:</b>	5 digits for WEIGHT.		
<b>∴:</b>	0x2Eh		
<b>kg:</b>	0x6Bh y 0x67h		
<b>B<sub>cc</sub>:</b>	Checksum, logical sum (XOR) from S of weight status.		
<b>E<sub>x</sub>:</b>	0x02h		
<b>E<sub>T</sub>:</b>	0x04h		

## 5.7.8. Delta Cash Register Protocol

### Protocol



#### Where:

<b>D:</b>	0x44h
<b>C<sub>R</sub>:</b>	0x0Dh
<b>L<sub>F</sub>:</b>	0x0Ah
<b>S:</b>	Sign
	+: 0x2Bh
	-: 0x2Dh
<b>WWWWW:</b>	6 digits for WEIGHT
<b>∴:</b>	0x2Eh

## 5.7.9. Alfa Cash Register Protocol

### Protocol



#### Where:

**S:** Sign.  
           +: 0x2Bh  
           -: 0x2Dh

**WWWWW:** 6 digits for WEIGHT.  
           .: 0x2Eh

**C<sub>R</sub>:** 0x0Dh  
**L<sub>F</sub>:** 0x0Ah

## 4.3.10. Samsung-Spain Cash Register Protocol

### Protocol

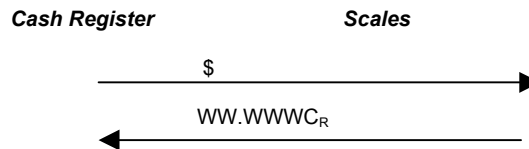

#### Where:

**\$ :** 0x24h

**WWWWW :** 6 digits for WEIGHT.  
           .: 0x2Eh                      **C<sub>R</sub> :** 0x0Dh

## 4.3.11. Samsung Portugal Cash Register Protocol

### Protocol



#### Where:

**W:** 0X57H, Weight request.  
**C<sub>R</sub>:** 0x0Dh  
**L<sub>F</sub>:** 0x0Ah  
**WWWWW:** 5 digits for WEIGHT.  
           .: 0x2E. Decimal point.  
**S:** 0x53h. Weight status.  
**00:** 0x30h, 0x30h. Whether correct weight status is activated.  
**KG:** 0x4Bh y 0x47h  
**E<sub>TX</sub>:** 0x03h

## 4.3.12. Uniprox / Bmc Ps 2000 Cash Register Protocol

### Protocol

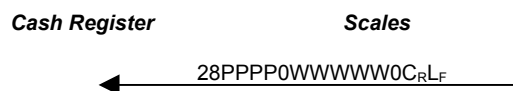

#### Where:

**0:** 0x30h  
**2 :** 0x32h                      **8 :** 0x38h  
**PPPP :** PLU Code            **C<sub>R</sub> :** 0x0Dh  
**WWWWW :** 5 digits for WEIGHT.    **L<sub>F</sub> :** 0x0Ah

**Note:** the WEIGHT-PRICE-SUM is not a protocol for the scales. WEIGHT-PLU CODE is, however, a protocol and therefore the keys in all the other protocols can be used to enter the product price, and thus calculate the sum. In this protocol, the PLU code to be sent to the cash register is determined. The row for the sum is cancelled in this protocol.





### 4.3.15. Kabel Cash Register Protocol

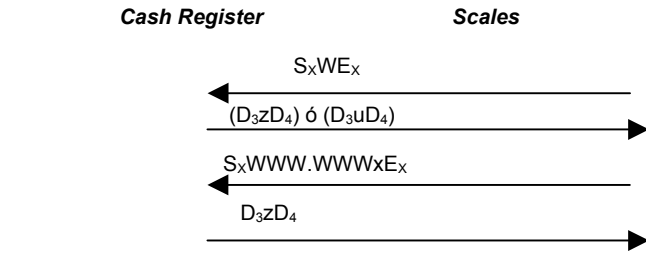

Where:

- |                        |                                       |
|------------------------|---------------------------------------|
| S <sub>x</sub> : 0x02h | z: 0x7Ah                              |
| E <sub>x</sub> : 0x03h | u: 0x75h                              |
| D <sub>3</sub> : 0x13h | W: 0x57h                              |
| D <sub>4</sub> : 0x14h | <b>WWW.WWW</b> : 6 digits for WEIGHT. |
| ∴: 0x2Eh               |                                       |

### 4.3.16. Nci Cash Register Protocol

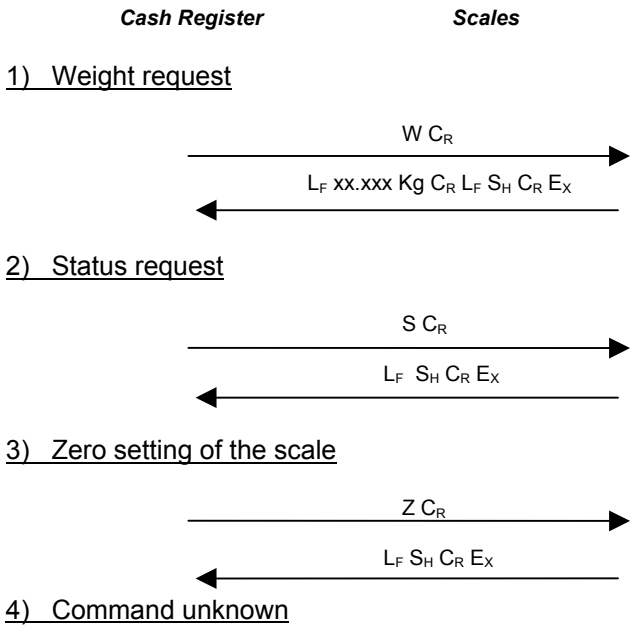

In case of not sending any of the previous commands, the scale answer "Command unknow"

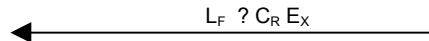

Were :

- |                        |                                    |
|------------------------|------------------------------------|
| W: 0x57h               | L <sub>F</sub> : 0x0Ah             |
| S: 0x53h               | E <sub>x</sub> : 0x03h             |
| Z: 0x5Ah               | S <sub>H</sub> : 0x01h             |
| ?: 0x3Fh               | <b>xxxxx</b> : 5 digits for WEIGHT |
| C <sub>R</sub> : 0x0Dh | <b>Kg</b> : 0x4Bh y 0x47h          |
| ∴: 0x2Eh Decimal point |                                    |



True copy of the manual deposited with notified body N° 317  
The information in this manual may be modified by the manufacturer without prior notice.  
Ref.: 49-TPOSE-PSC-EN02 REV 03 10/04/07

**Astintze, 24 - Pol. Ind. Neinver - 48160 - DERIO (VIZCAYA) - SPAIN . Tel: (+34) 94 452 15 10 - Fax: (+34) 94 452 36 58**

**[www.dibal.com](http://www.dibal.com)**

**DIBAL**

The logo for DIBAL features the word "DIBAL" in a bold, sans-serif font. Below the text is a thick horizontal line. From the center of this line, two diagonal lines extend upwards and outwards, meeting the bottom of the letters "I" and "A", creating a stylized, wing-like or arrow-like shape.